

# CITY OF RIDGELAND COUNTY LINE RD.

## PHASE I

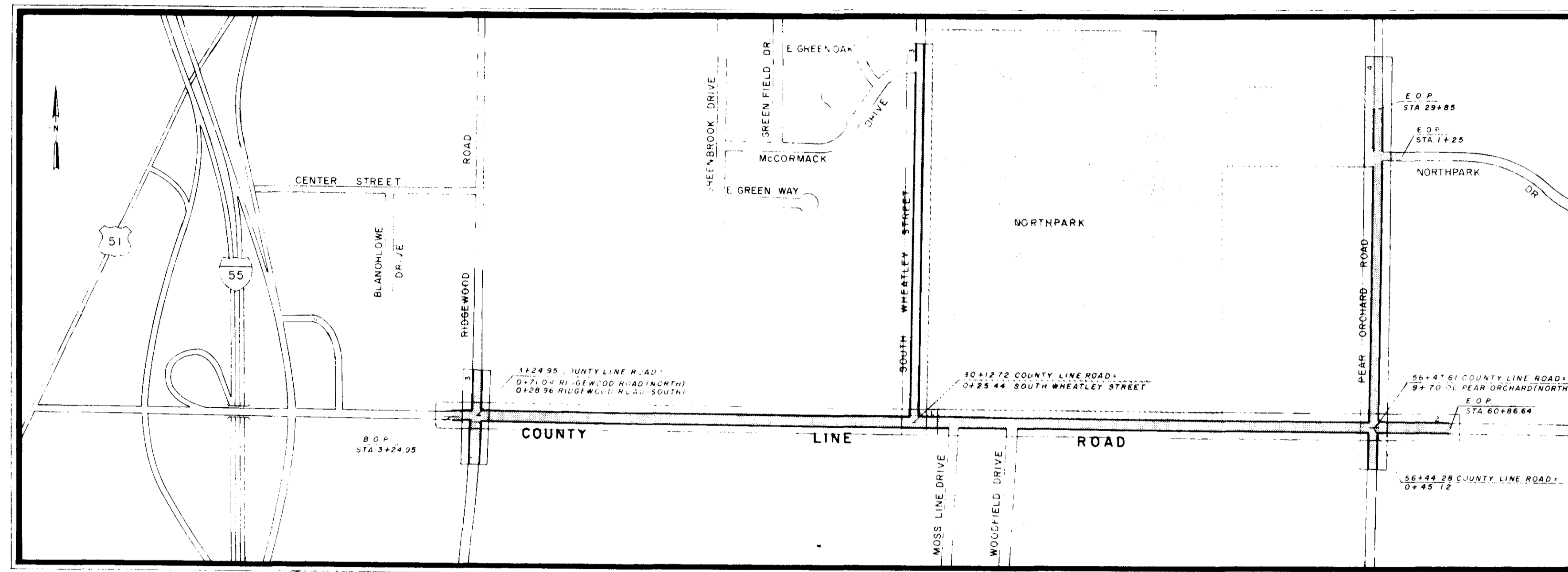

Mayor:  
Hite B. Wolcott

Mayor Pro Tem:  
Hilda Boyd

City Attorney:  
Milton Case

Aldermen:

Al Bible  
Hilda Boyd  
Harvey Carr, Jr.  
Gene McGee  
Gilbert Sollek

Public Works Director  
Horace M. Ross

MARCH, 1986

# RECONSTRUCTION AND EXPANSION SURFACE COURSE APPLICATION AND STRIPING

Waggoner Engineering Inc.  
Consulting Engineers  
Brandon/Jackson, Ms.

PWP-00310

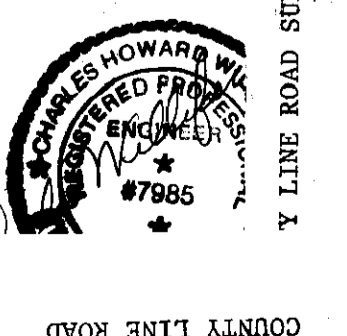

County Line Road  
Line Rd.  
Surface

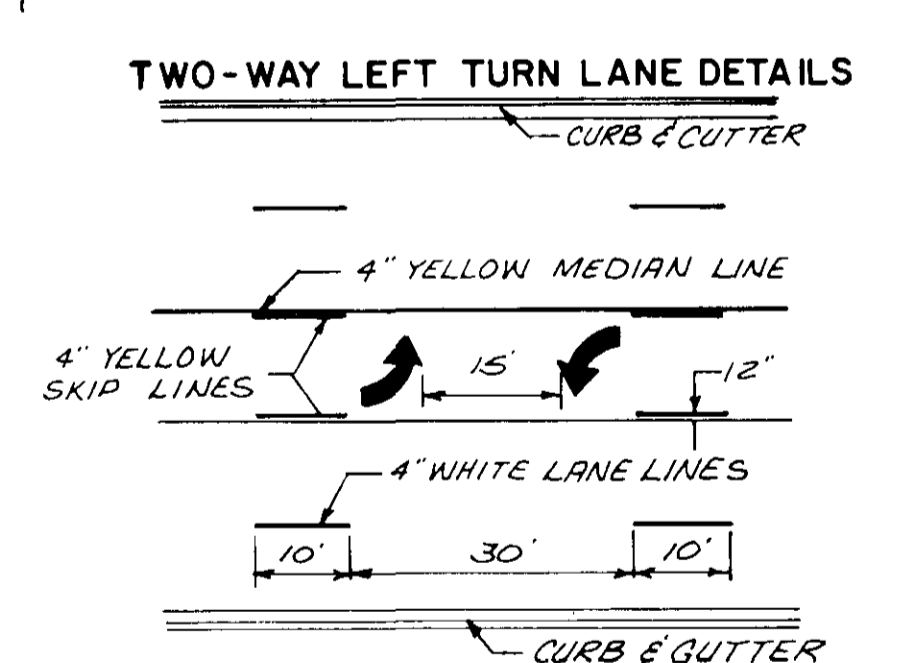
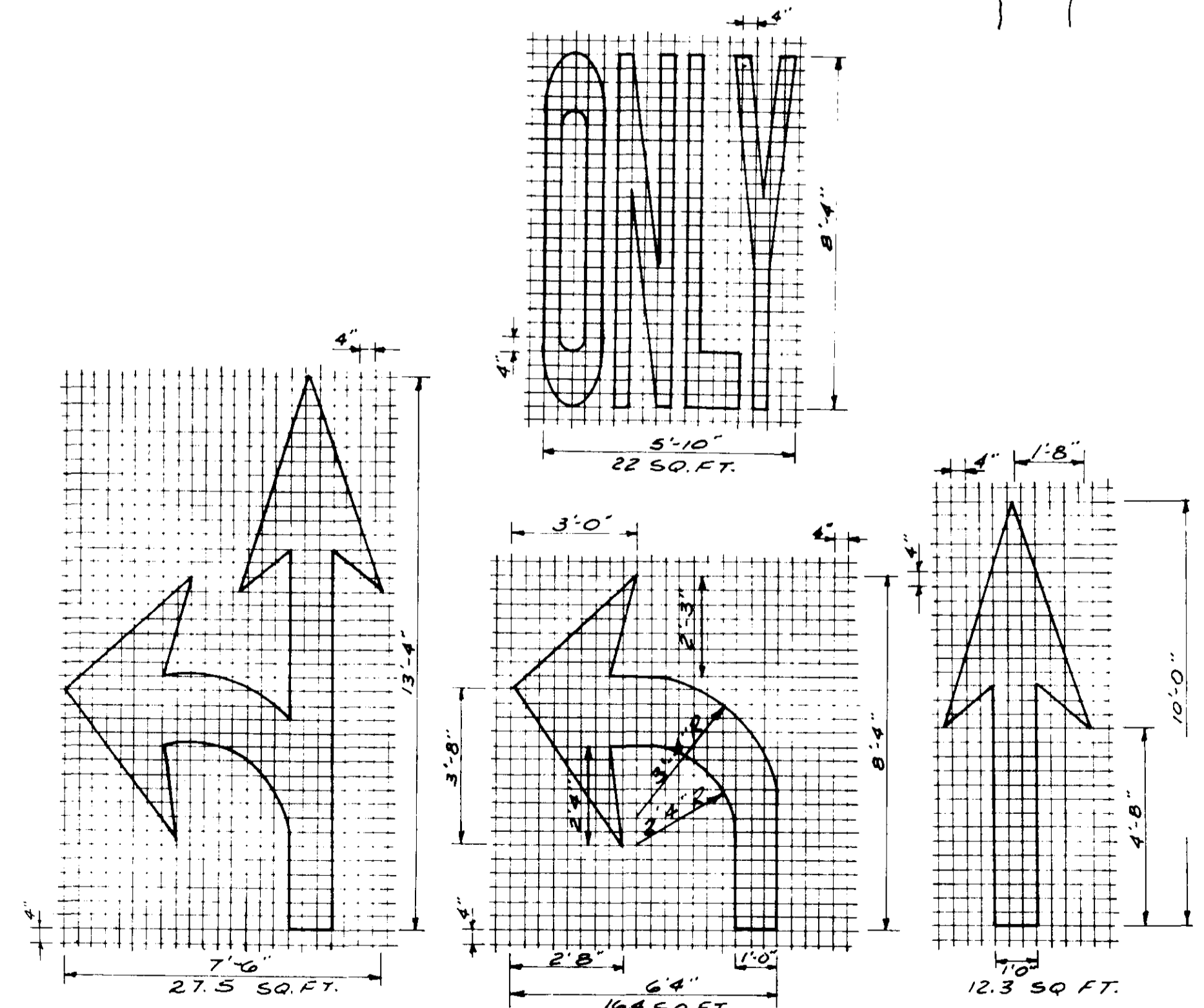
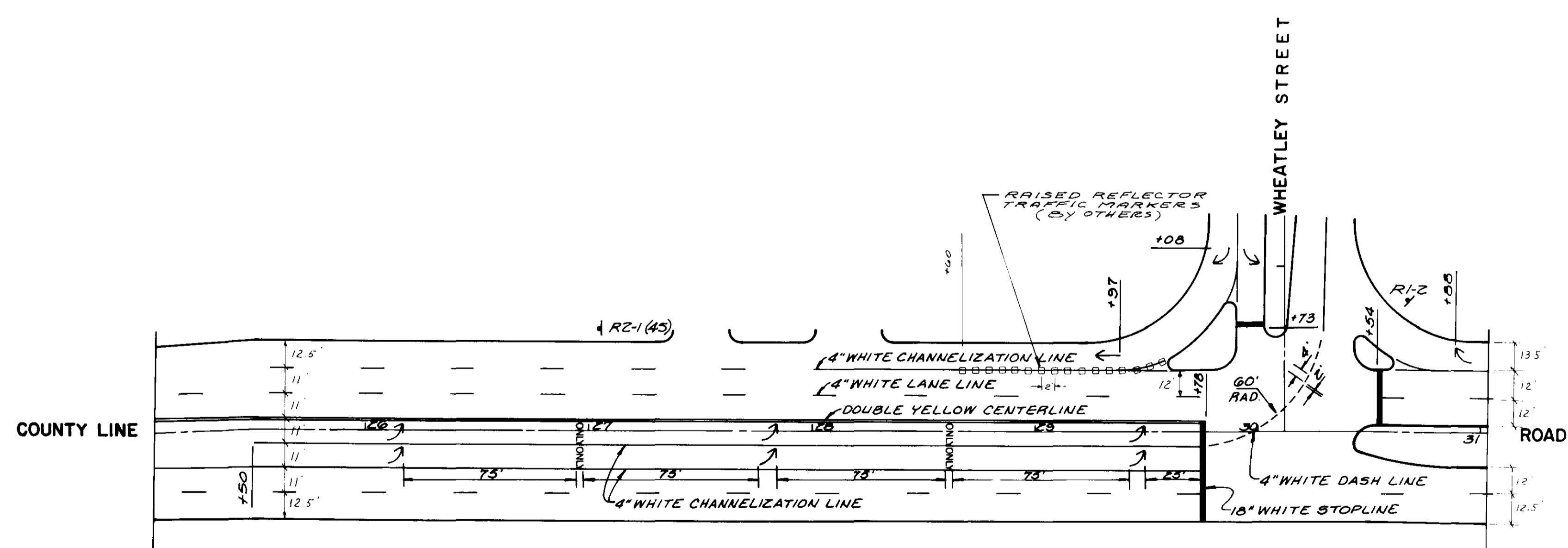
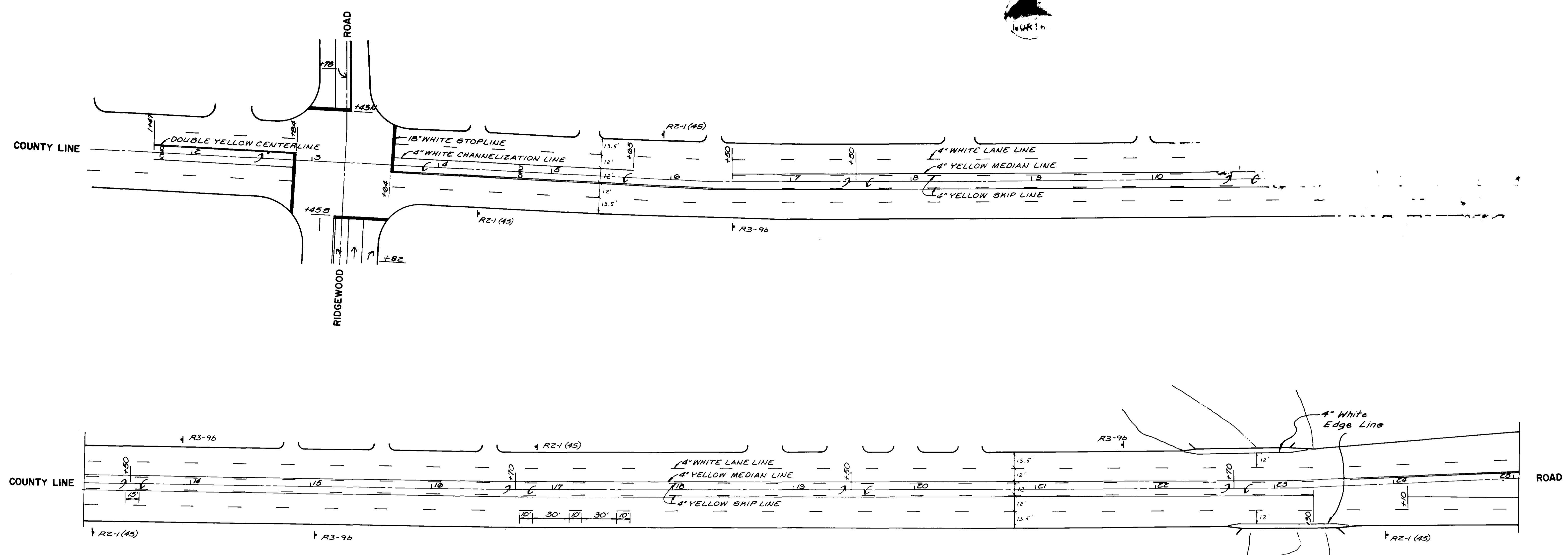

NOTE: RIGHT TURN AND COMBINATION RIGHT TURN/STRAIGHT ARROWS ARE REVERSE OF ARROWS SHOWN

CITY OF RIDGELAND, MISSISSIPPI		
COUNTY LINE ROAD RECONSTRUCTION & EXPANSION		
PAVEMENT MARKING PLAN		
STATION 1+47 TO 31+03		
COUNTY LINE ROAD		
RIDGELAND, MISSISSIPPI		
JOE A. WAGGONER Civil Engineer - Brandon/Jackson, Miss.		
DRAWN BY: M.H.L.	DATE: 3-28-86	SHEET NO.
CHECKED BY: J.A.W.	SCALE: 1"=40'	1 OF 5

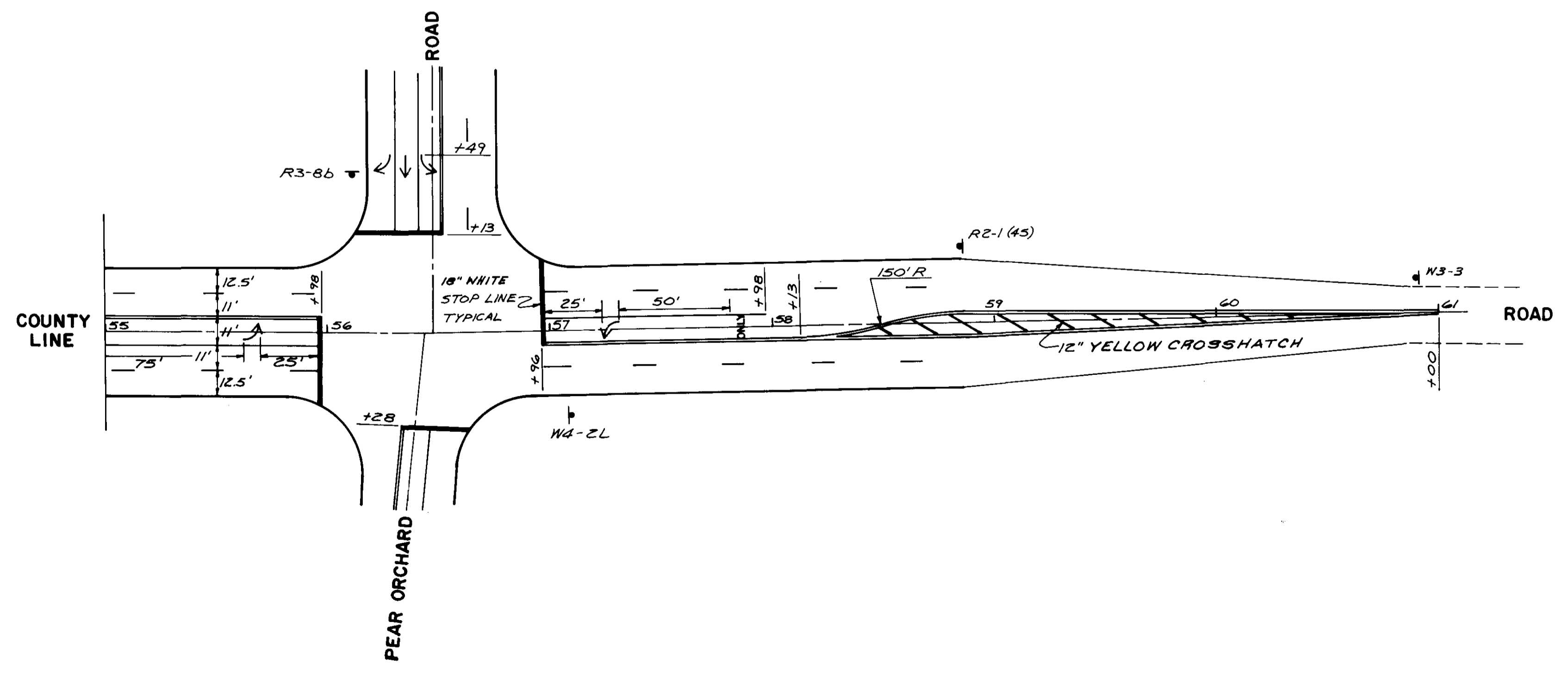
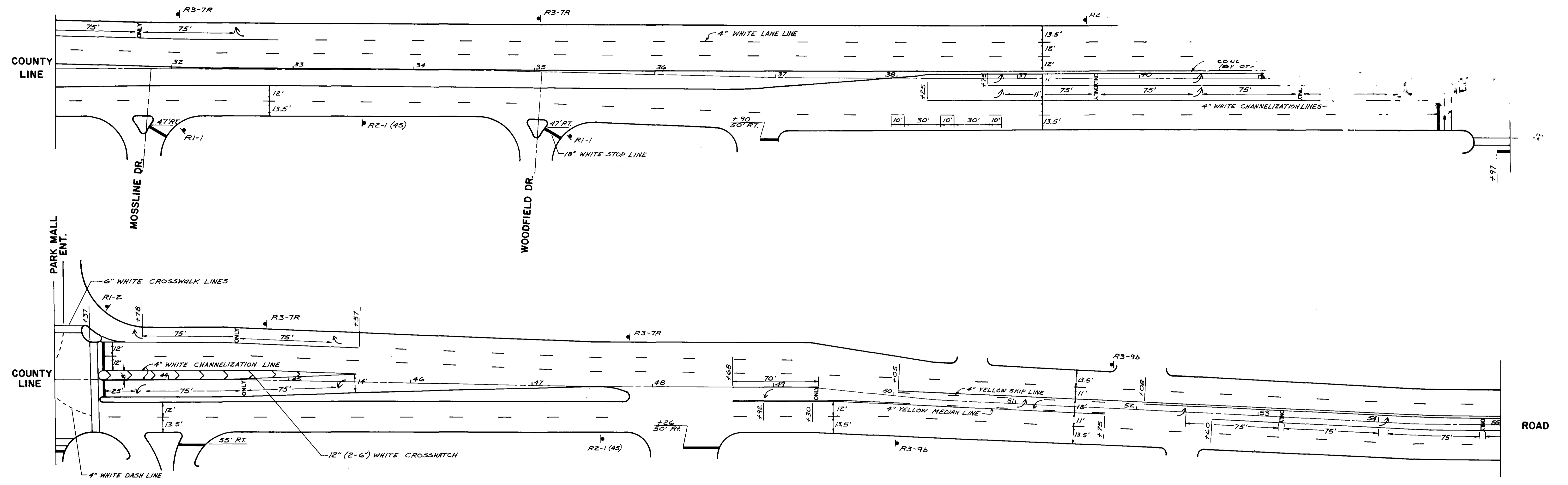

CITY OF RIDGLAND, MISSISSIPPI		
COUNTY LINE ROAD RECONSTRUCTION & EXPANSION		
PAVEMENT MARKING PLAN STATION 31+03 TO 61+00 COUNTY LINE ROAD RIDGLAND, MISSISSIPPI		
JOE A. WAGGONER Civil Engineer - Brandon/Jackson, Miss.		
DRAWN BY: MRL	DATE: 3-28-86	SHEET NO.
CHECKED BY: JAW	SCALE: 1" = 40'	2 OF 5

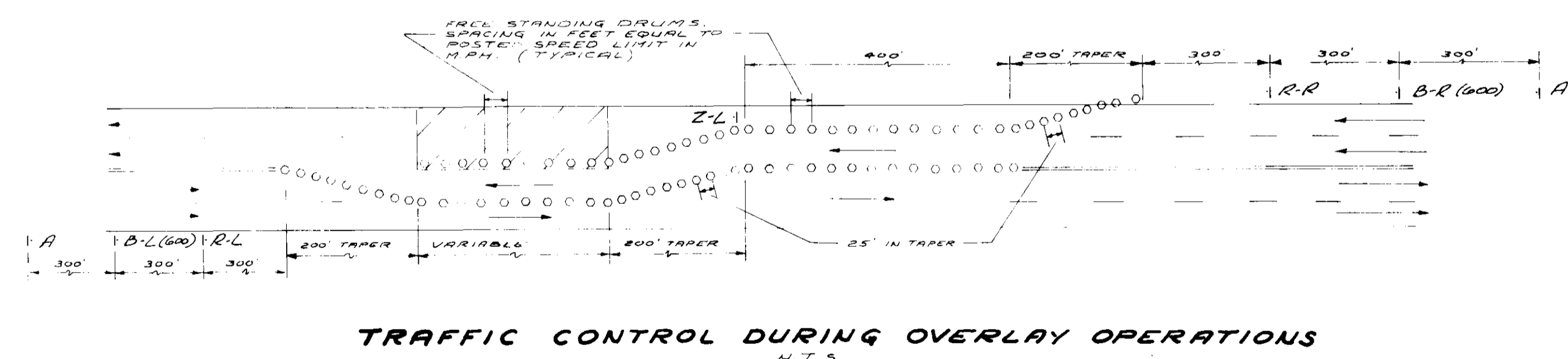
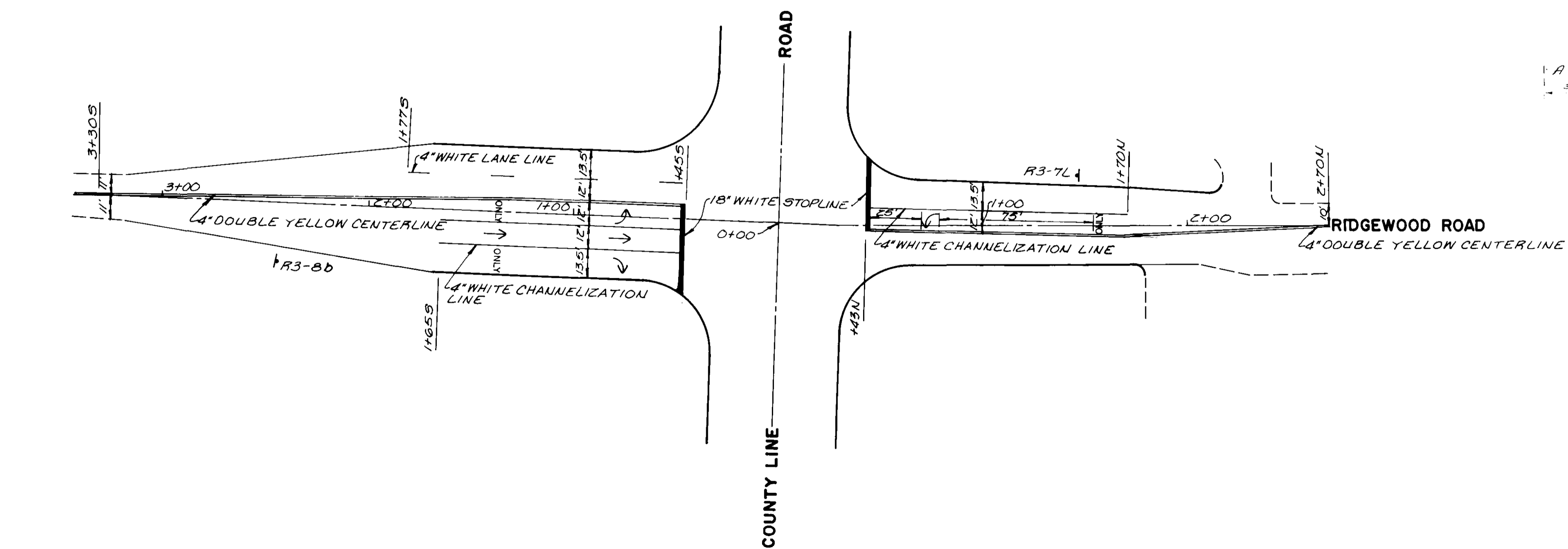
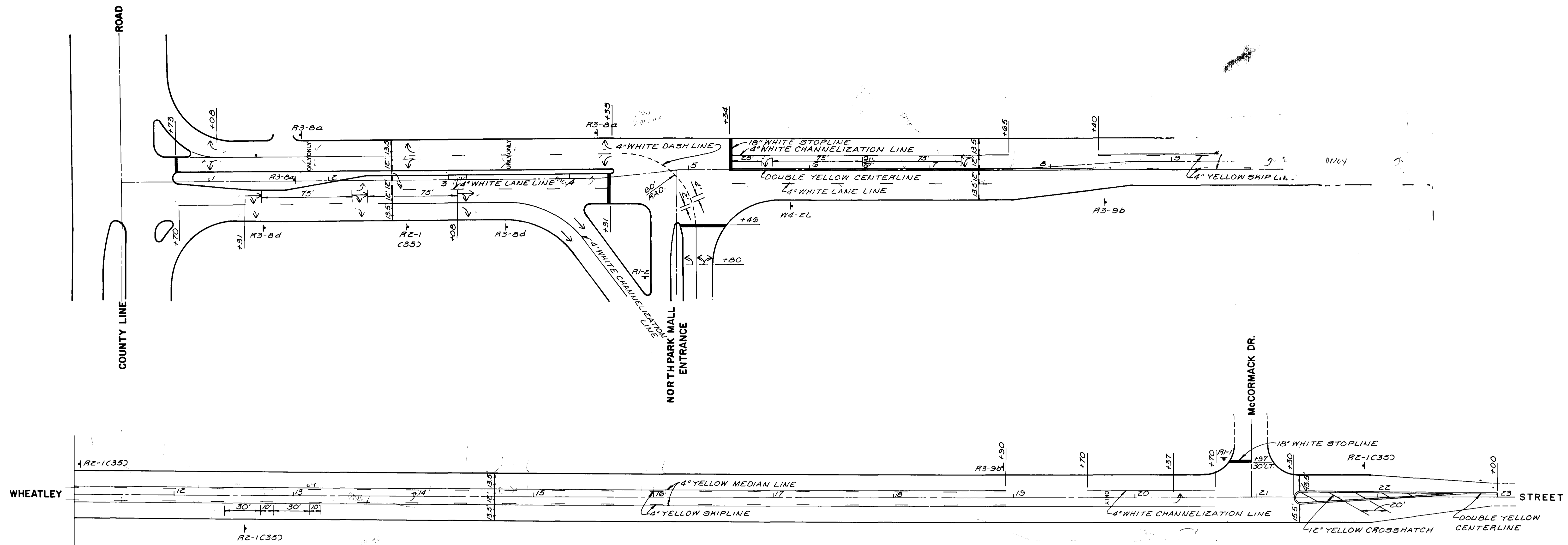

CITY OF RIDGELAND, MISSISSIPPI

COUNTY LINE ROAD  
RECONSTRUCTION & EXPANSION

PAVEMENT MARKING PLAN  
WHEATLEY STREET AND  
RIDGEWOOD ROAD  
RIDGELAND, MISSISSIPPI

---

JOE A. WAGGONER  
Civil Engineer - Brandon/Jackson, Miss.

DRAWN BY: M.A.L.	DATE: 3-22-36	SHEET NO.
CHECKED BY: J.A.W.	SCALE: 1"=40'	3 OF 5

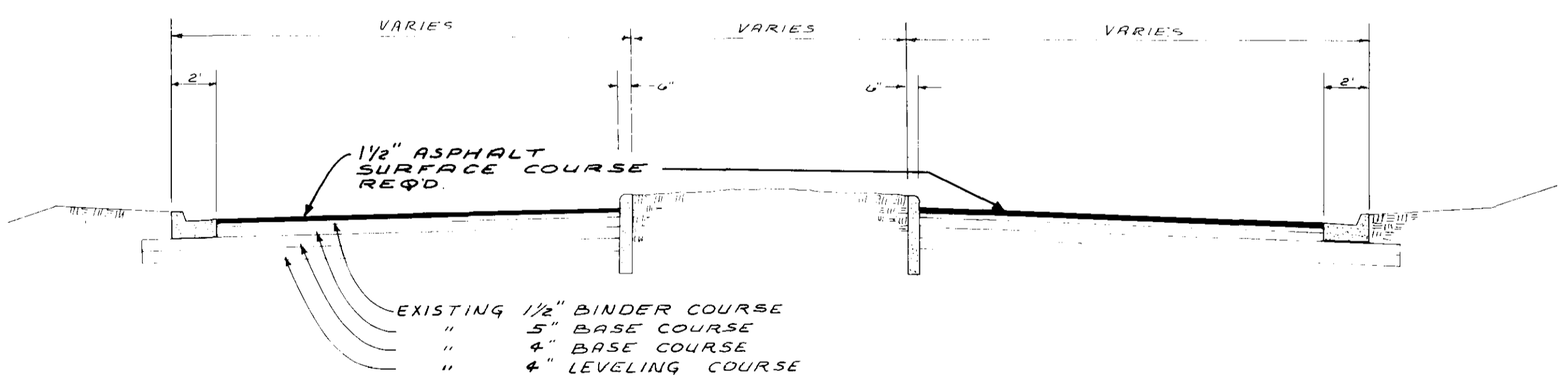
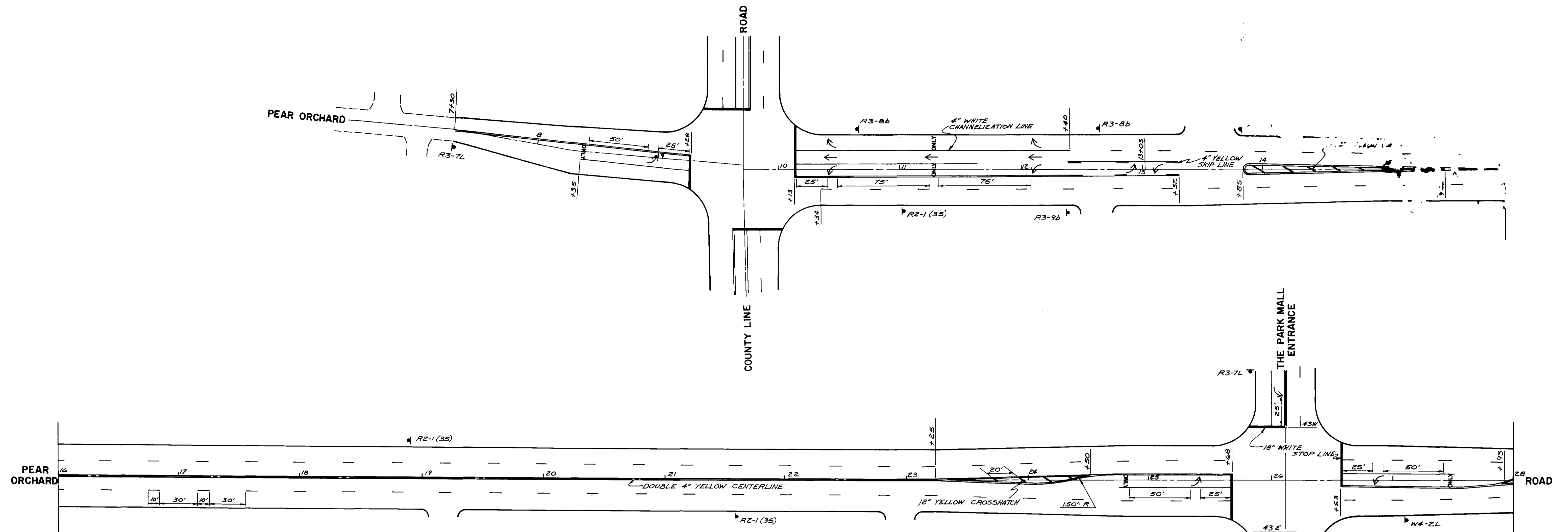

TYPICAL MEDIAN SECTION  
N.T.S.

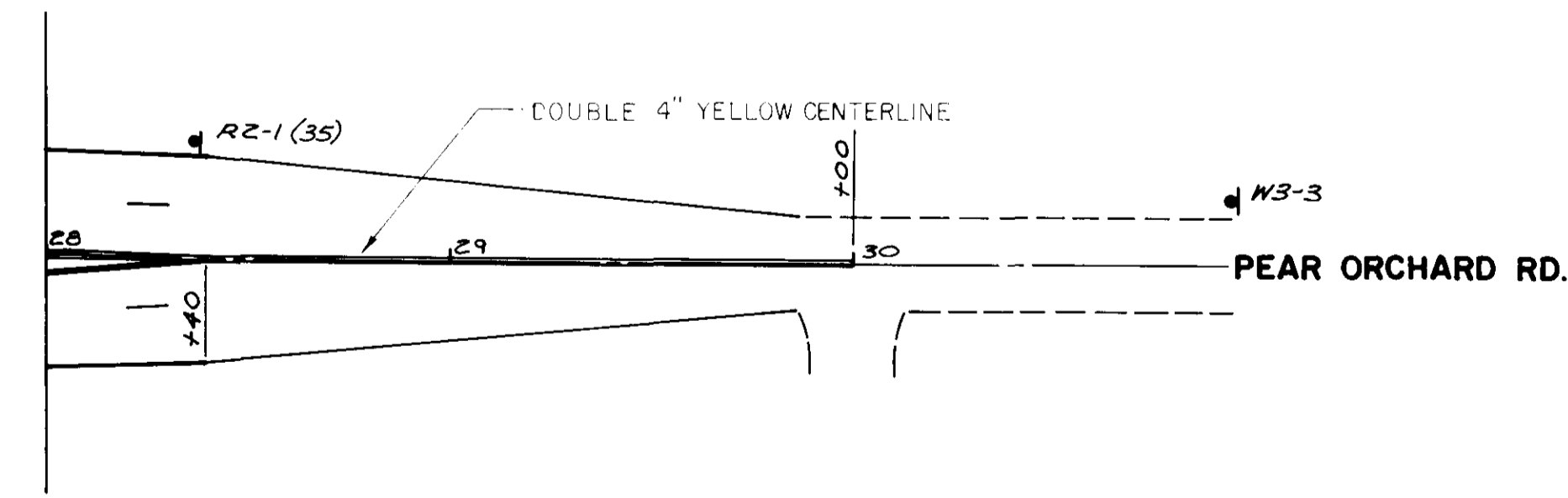

TYPICAL CURB & GUTTER SECTION  
N.T.S.

CITY OF RIDGELAND, MISSISSIPPI		
COUNTY LINE ROAD RECONSTRUCTION & EXPANSION		
PAVEMENT MARKING PLAN STATION 7+30 TO 30+00 PEAR ORCHARD ROAD RIDGELAND, MISSISSIPPI		
JOE A. WAGGONER Civil Engineer - Brandon/Jackson, Miss.		
DRAWN BY: M.P.L.	DATE: 3-28-86	SHEET NO.
CHECKED BY: J.R.W.	SCALE: 1" = 40'	4 OF 5

BLACK MESSAGE ON ORANGE REFLECTIVE BACKGROUND - SIGNS A THRU K MIN. SIZE (30" x 30")

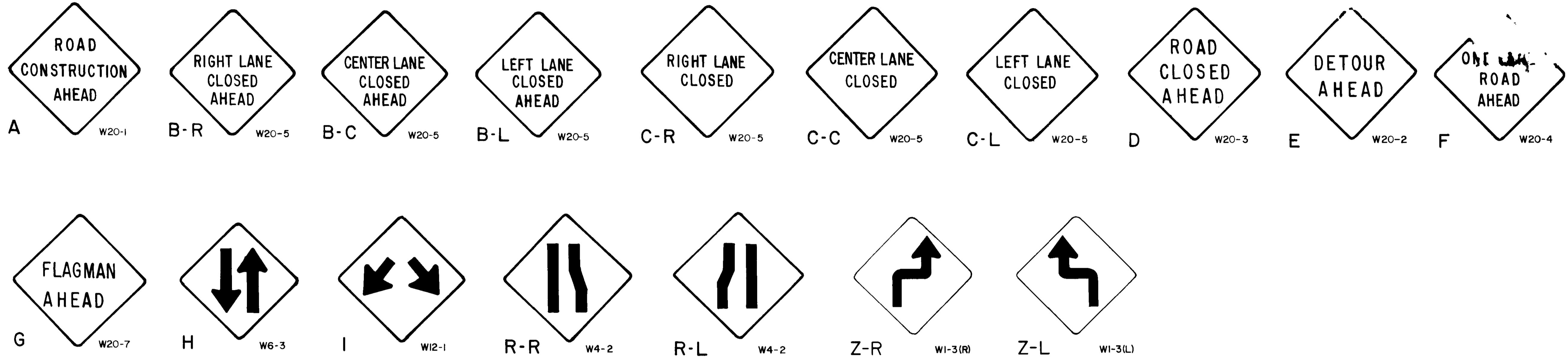

NOTE:  
STREET NAME SIGN (8" x 30")  
REQUIRED ON ALL M4-9  
SERIES SIGNS (IF REQUIRED).

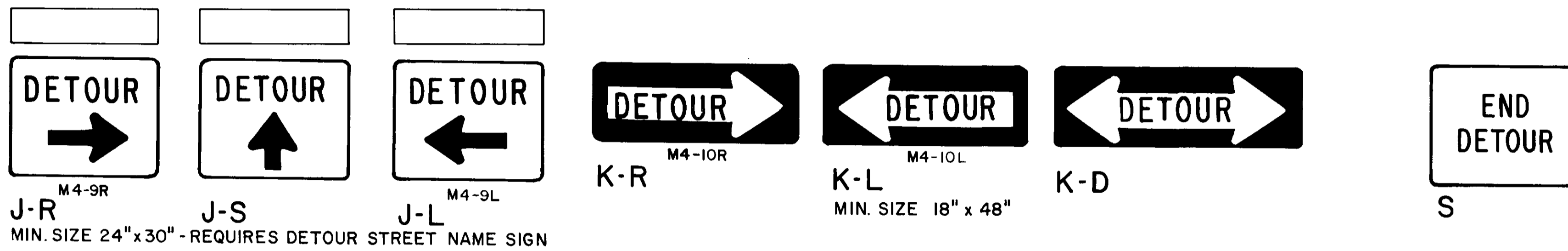

BLACK MESSAGE ON WHITE REFLECTIVE BACKGROUND

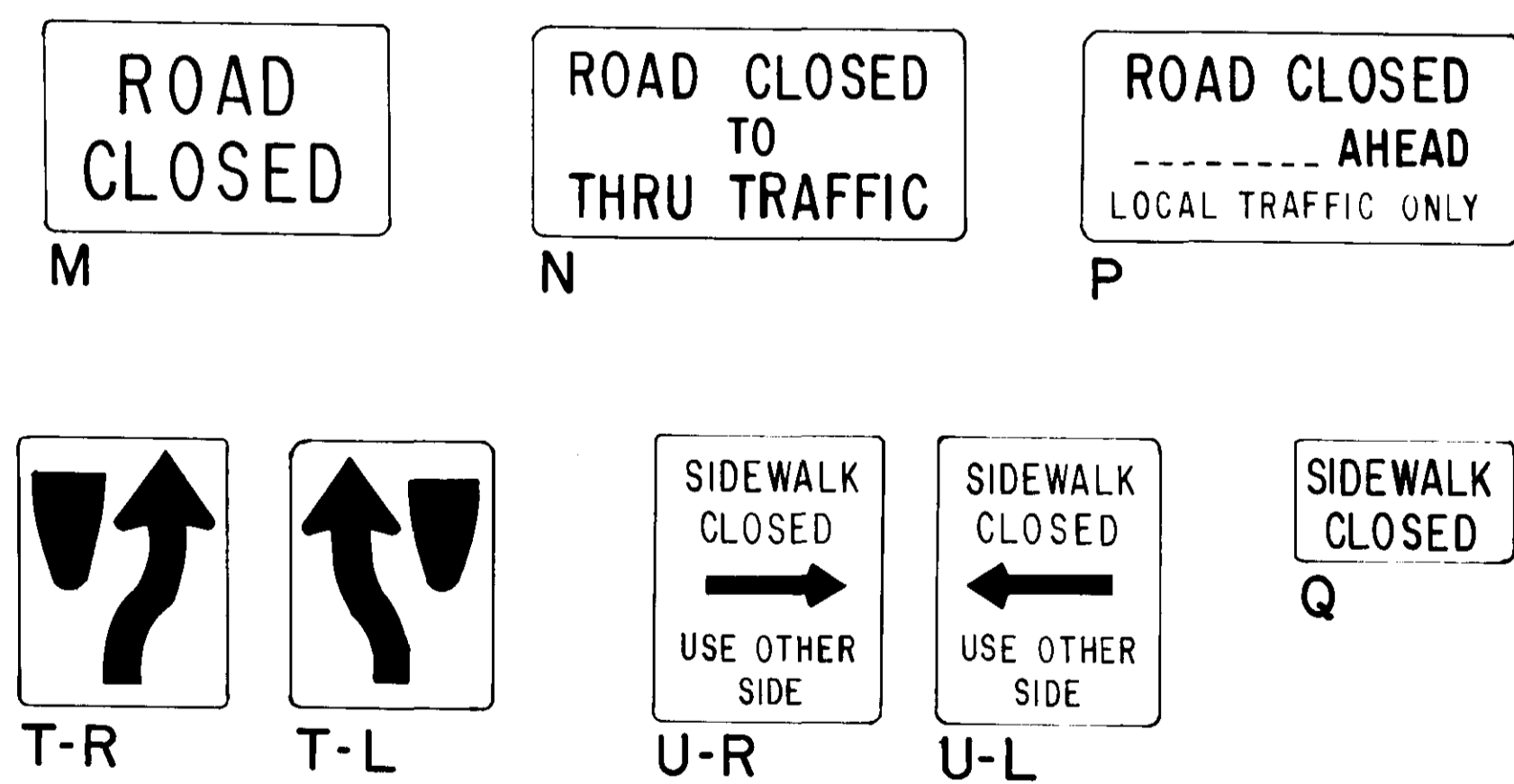

NOTE: TYPE "A" LIGHTS AS REQUIRED BY SECTION 10.04 MAINTENANCE OF TRAFFIC SIGNIFICATION.

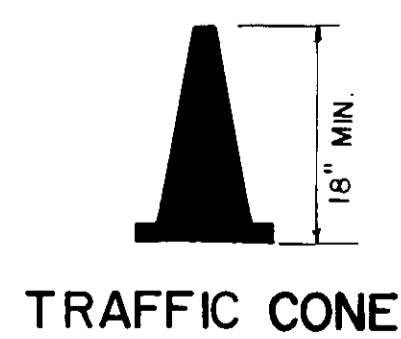
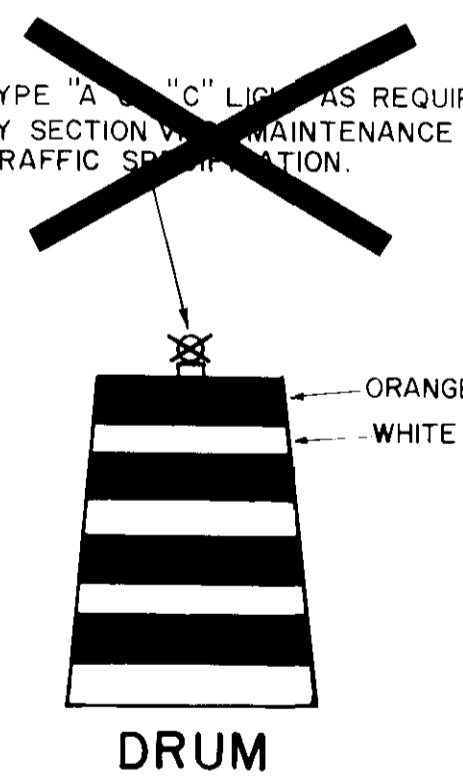

ALTERNATE TYPE III BARRICADE

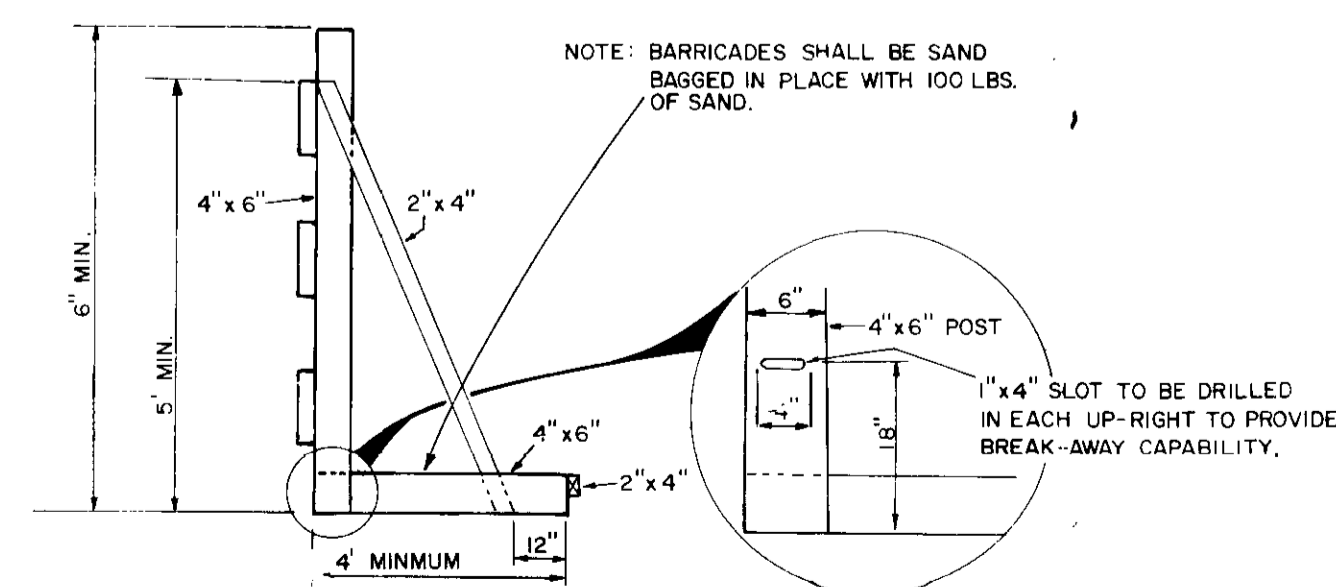
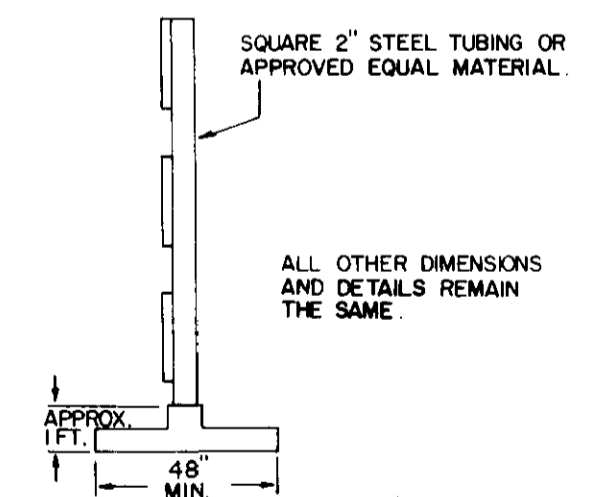
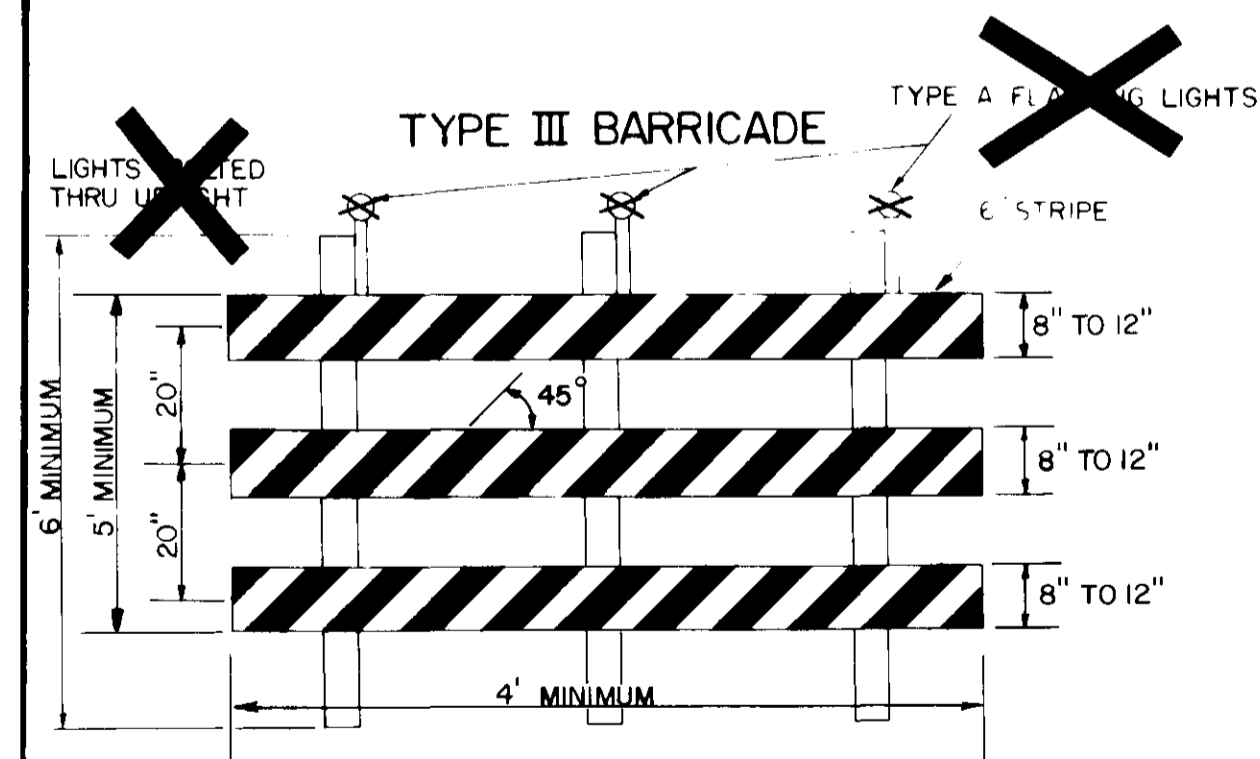

REVNO	RELEASED BY	DESCRIPTION OF REVISION

STANDARD SIGNS FOR MAINTENANCE OF TRAFFIC DURING CONSTRUCTION

DSGN		DRAWING NO.
DRWN	MAL	5 of 5
CHKD		
APPR	JAW	

CONSTRUCTION