

CITY OF RIDGELAND, MISSISSIPPI
RIDGEWOOD ROAD
ROADWAY CONSTRUCTION PLANS

Mayor:
Gene F. McGee

Mayor Pro Tem:
Harvey Carr, Jr.

City Attorney:
Jerry Mills

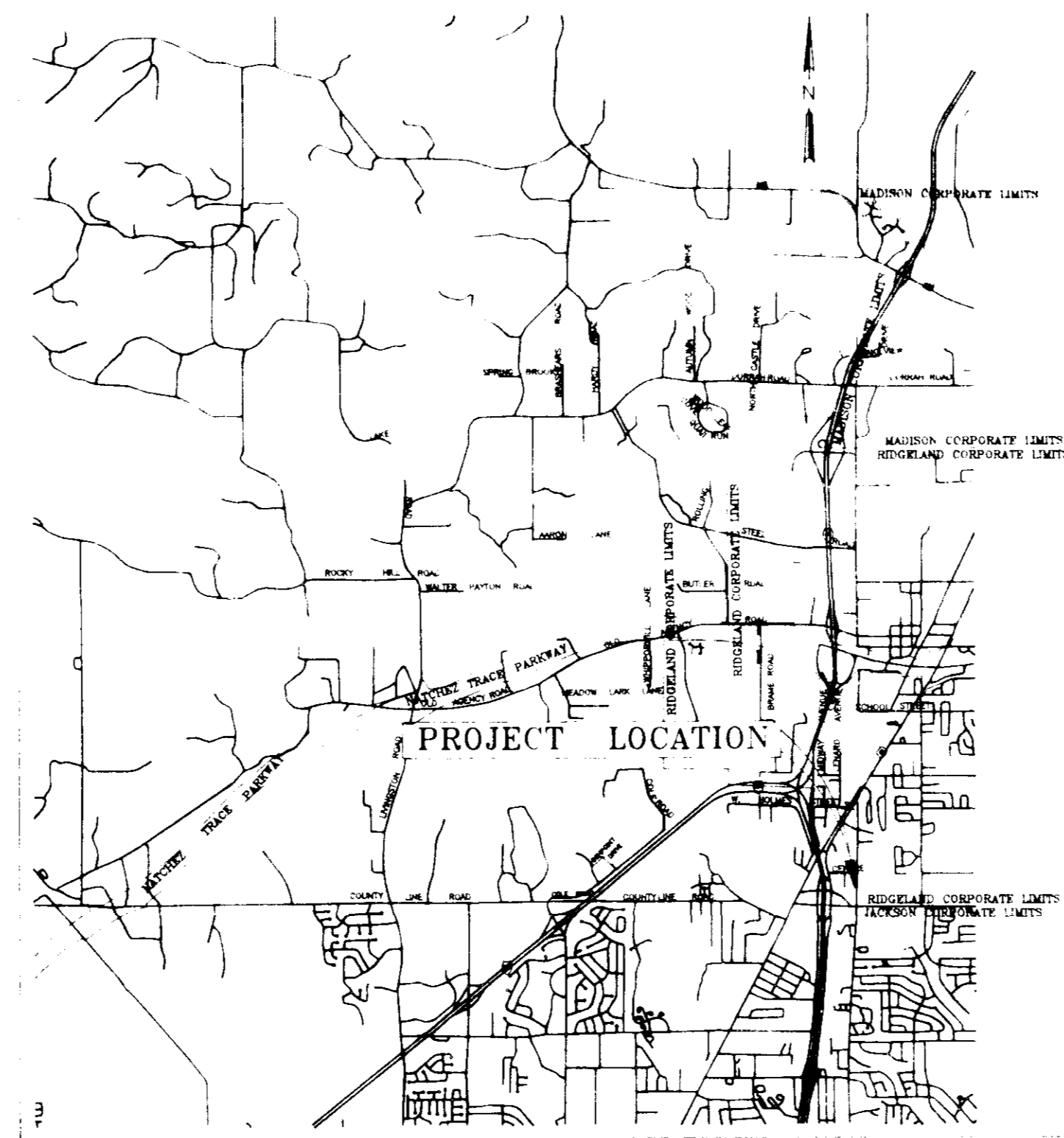

VICINITY MAP

MAY , 1990

WAGGONER ENGINEERING, INC.
Consulting Engineers
Jackson, Mississippi

Aldermen:

Brian Barcellona
Al Bible
Harvey Carr, Jr.
Linda Davis
Daryl Smith

Public Works Director:
Sam Vinson

City Clerk:
Michael McPhearson

PWP-01814

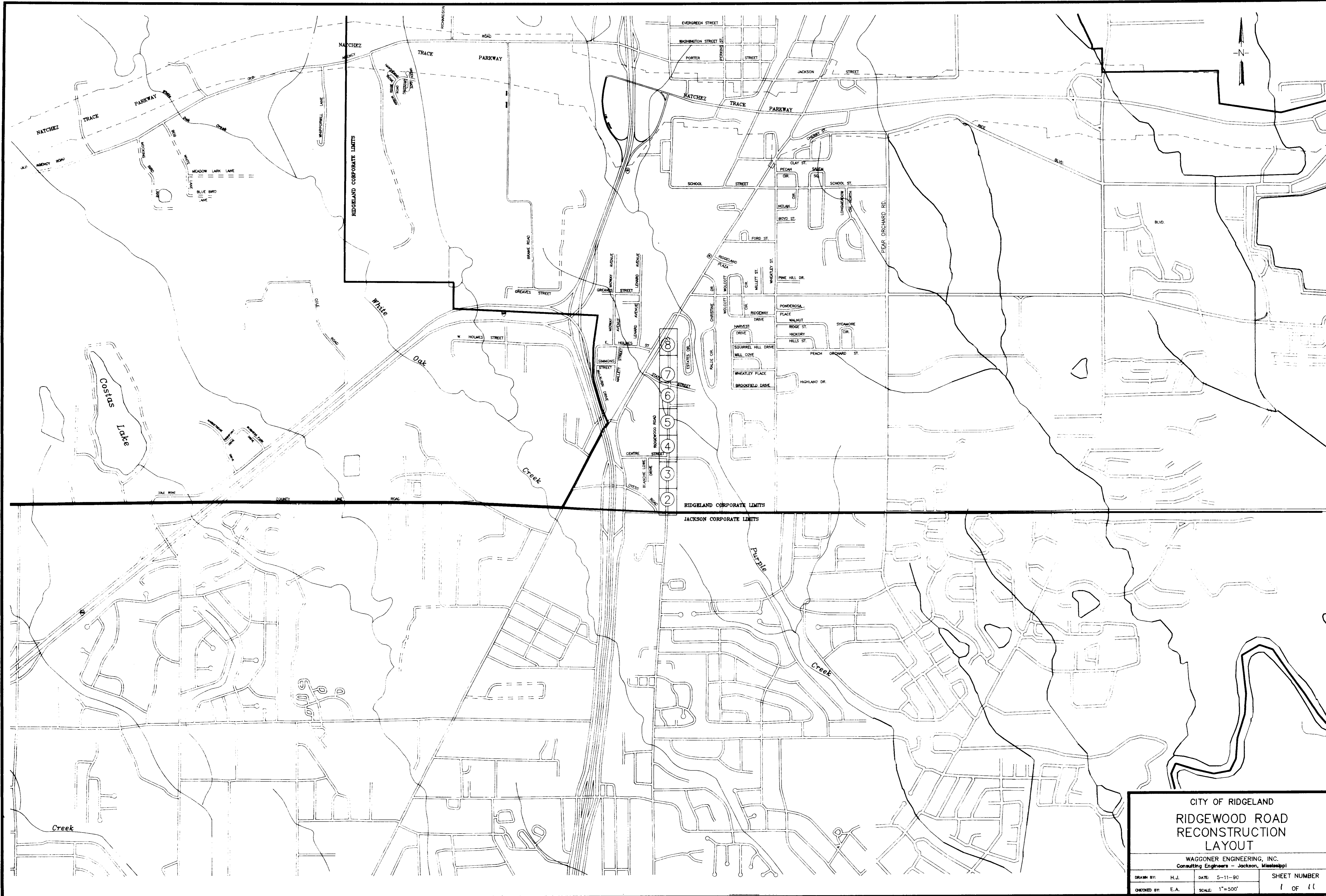

CITY OF RIDGELAND RIDGEWOOD ROAD RECONSTRUCTION LAYOUT			
WAGGONER ENGINEERING, INC. Consulting Engineers - Jackson, Mississippi			
DRAWN BY: H.J.	DATE: 5-11-90	SHEET NUMBER	
CHECKED BY: E.A.	SCALE: 1"=500'	1 OF 11	

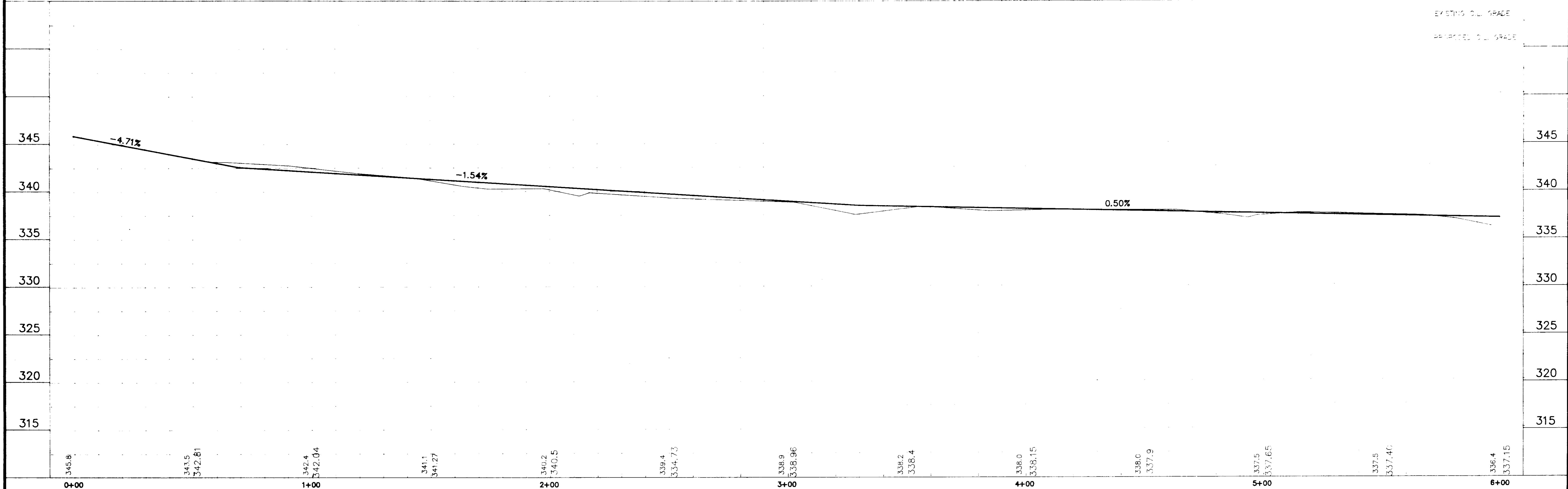
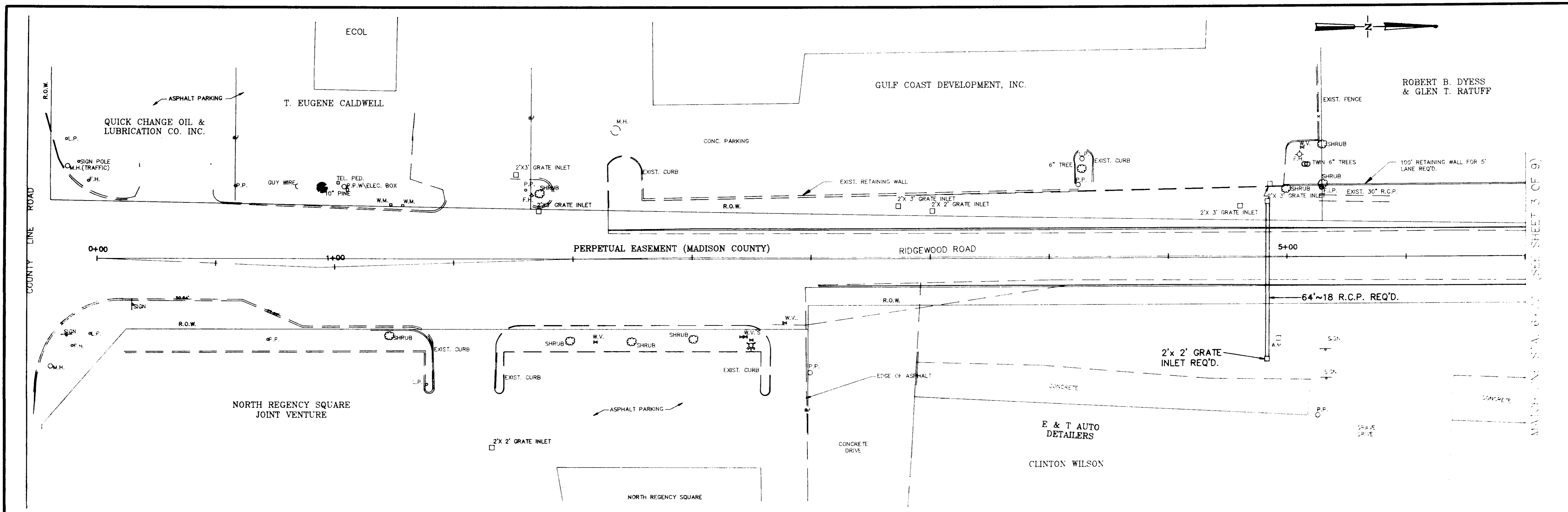

DESIGNED		DATE		WAGNER ENGINEERING INC. CONSULTING ENGINEERS JACKSON, MISSISSIPPI		RIDGEWOOD ROAD		ACAD PATH ROUTE	
DRAWN		SCALE						W.E.I. JOB NO.	SHEET N°
BY <i>R. Bounds</i>		1" = 20' HORT.				2 OF 11			

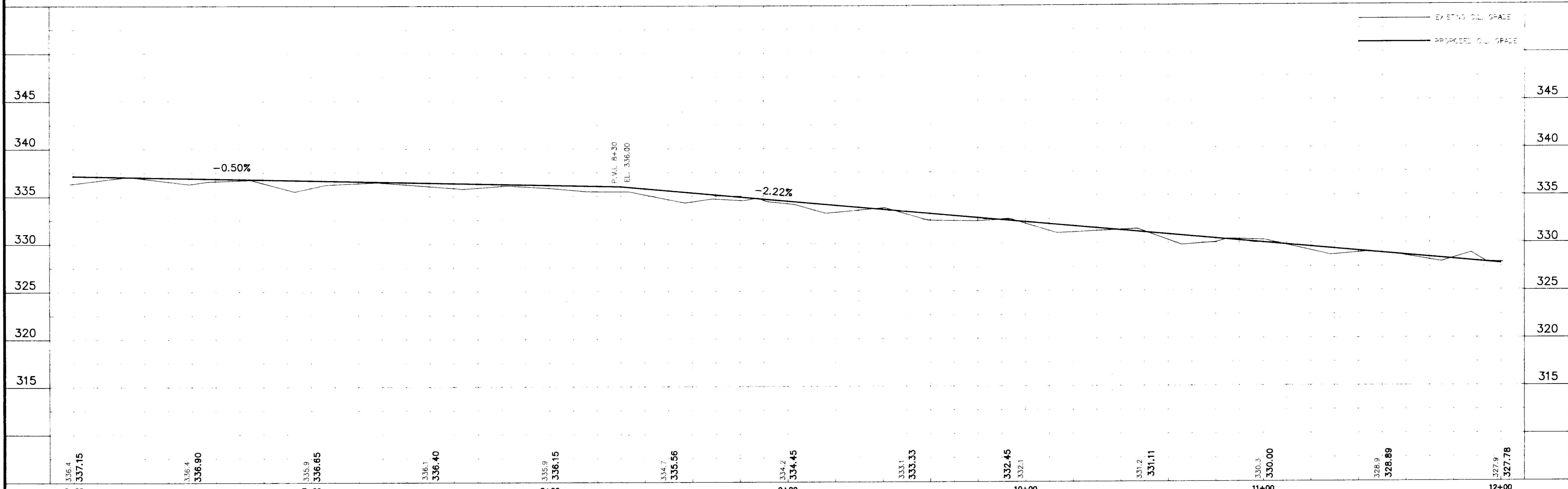
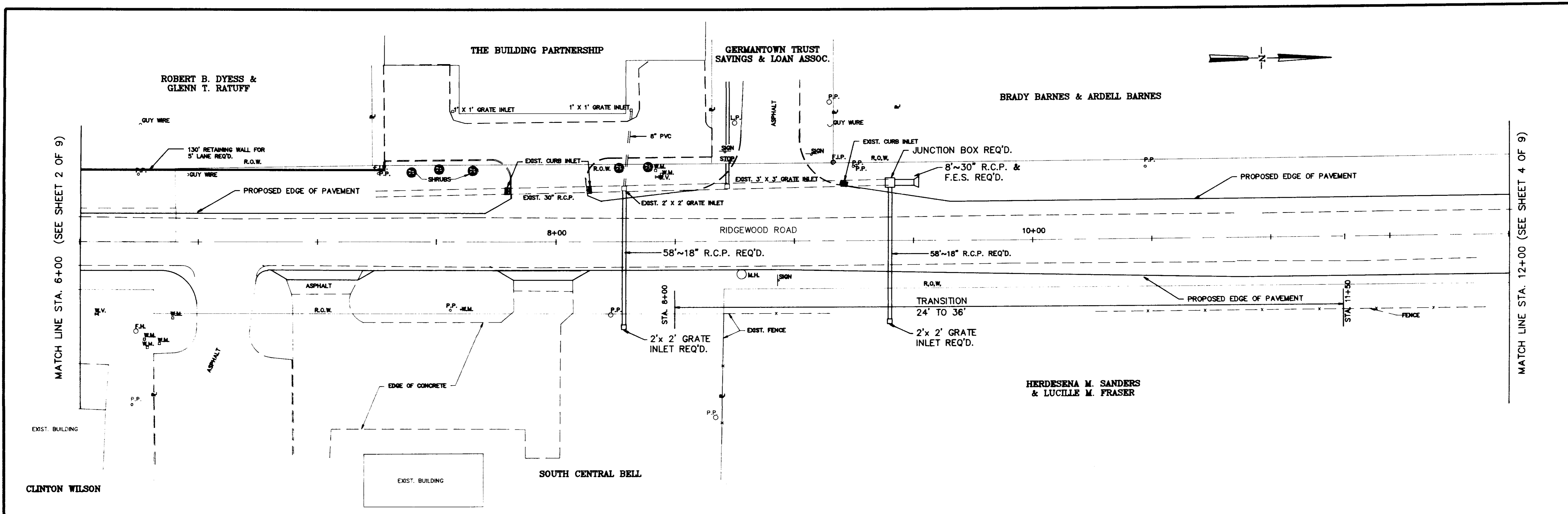

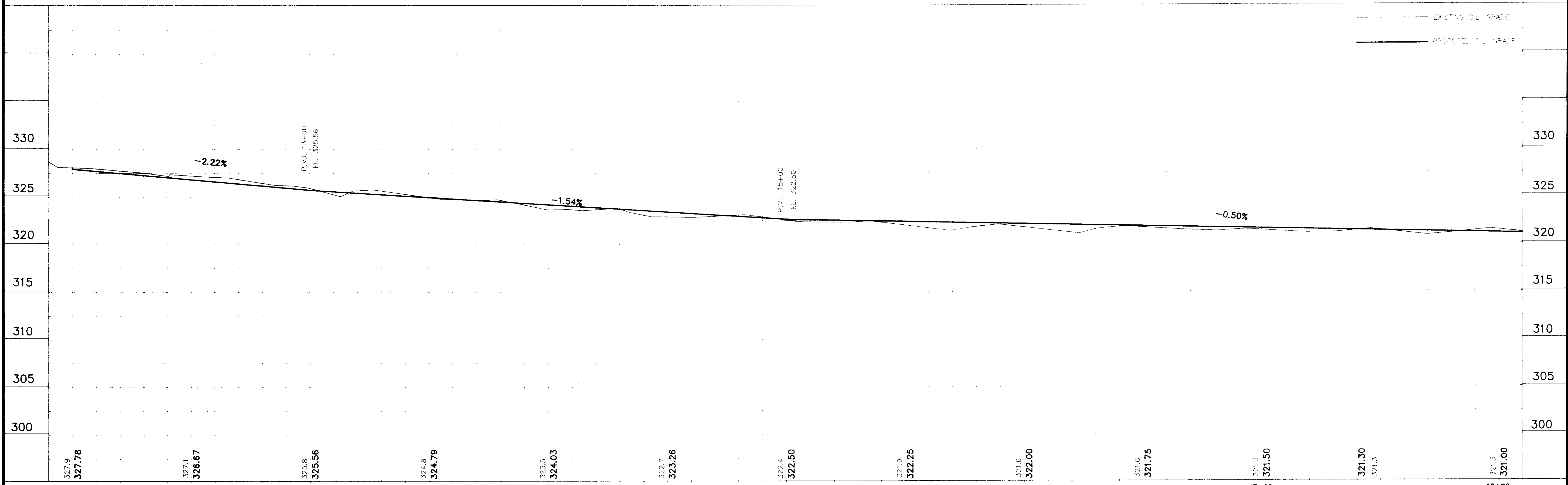
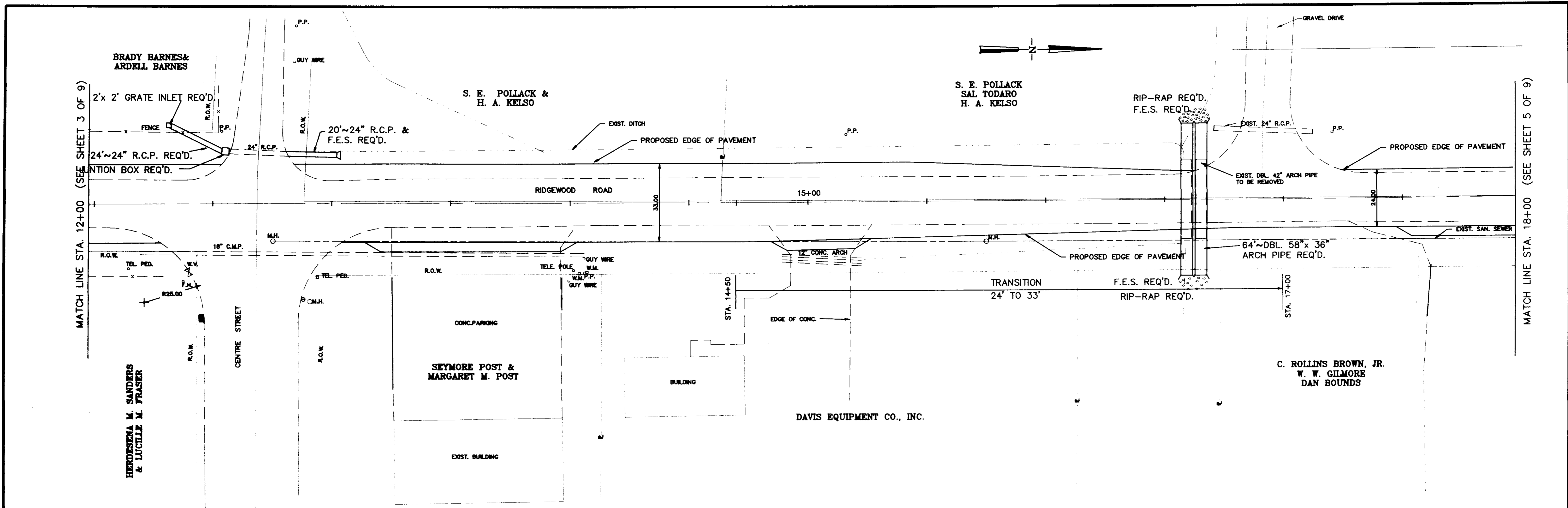

NO. DATE		REVISIONS		DESIGNED	DATE	WAGGONER ENGINEERING INC. CONSULTING ENGINEERS JACKSON, MISSISSIPPI				RIDGEWOOD ROAD		ACAD PATH ROUTE	
				DRAWN	SCALE							W.E.I. JOB NO.	
				BY	SCALE							SHEET NO.	
					1"=20' HORT. 1"=5' VERT.							4 OF 11	

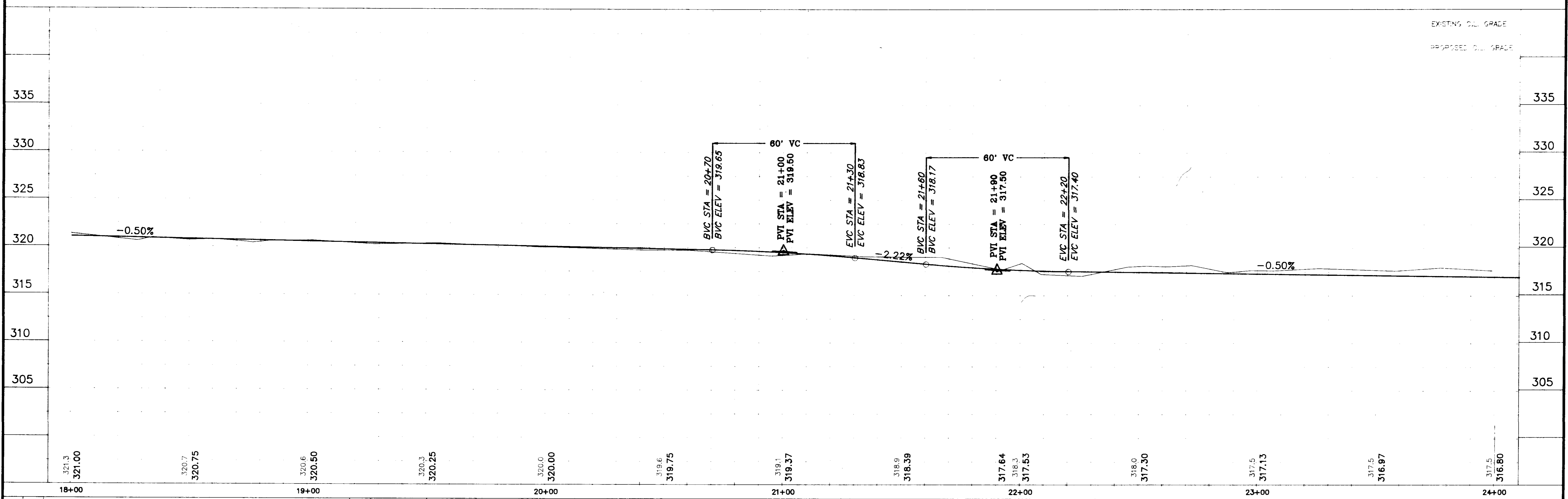
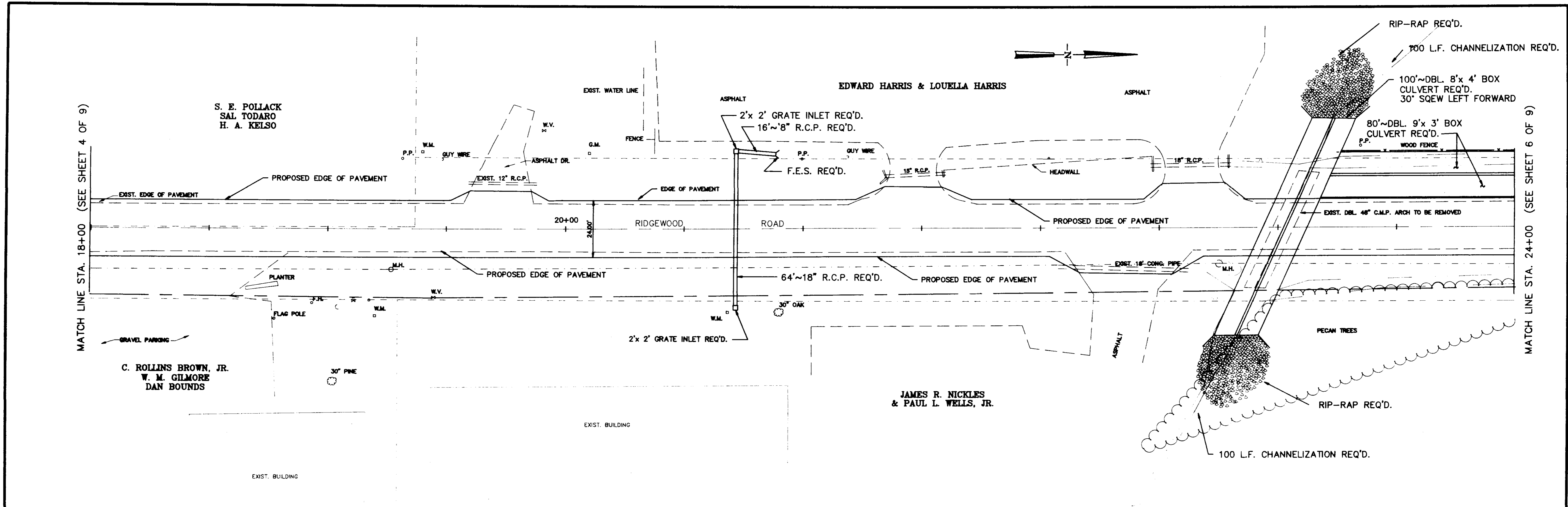

DESIGNED		DATE		WAGGONER ENGINEERING INC. CONSULTING ENGINEERS JACKSON, MISSISSIPPI		RIDGEWOOD ROAD		ACAD PATH ROUTE	
DRAWN		SCALE						W.E.I. JOB NO.	
BY <i>R. Bounds</i>		1"=20' HORT. 1"=5' VERT.						5 OF 11	

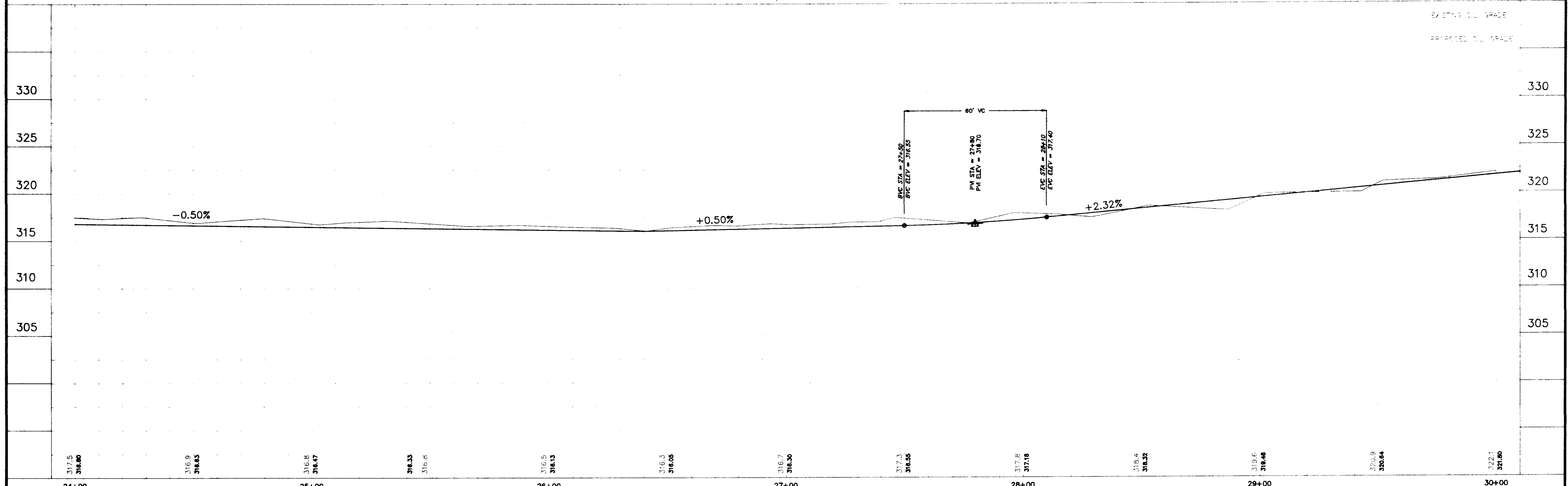
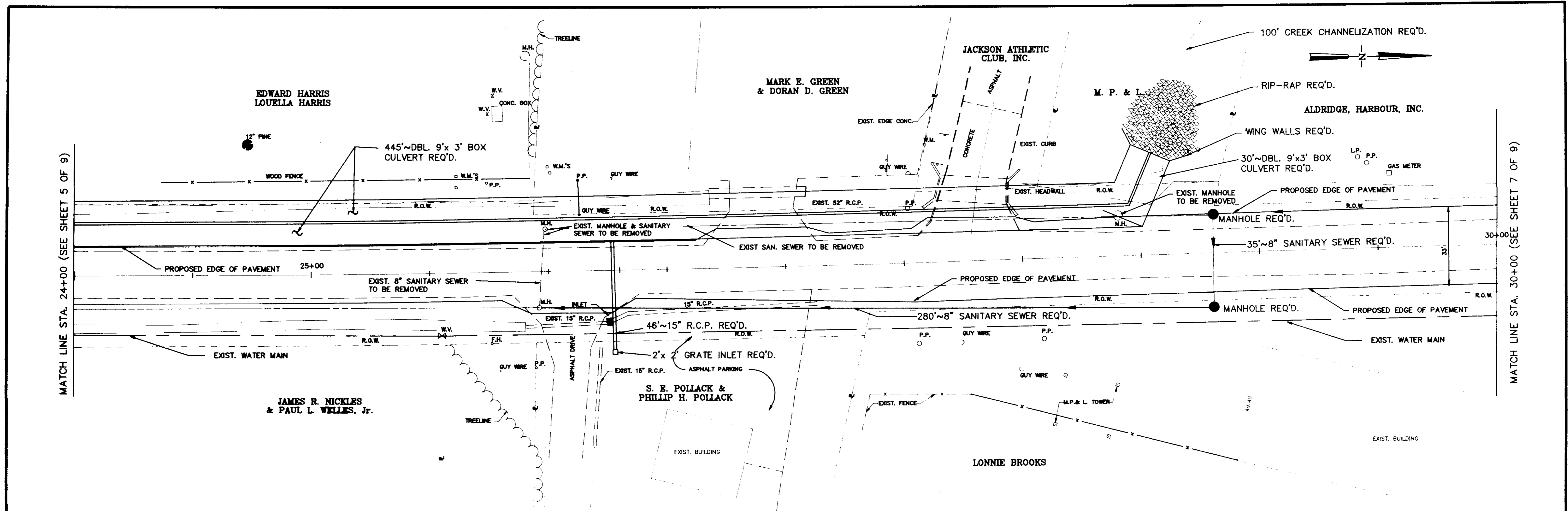

317.5 316.80	316.9 316.63	316.8 316.47	316.33 316.8	316.5 316.13	316.3 316.05	316.7 316.30	317.3 316.55	317.8 317.16	318.4 316.32	319.6 318.46	320.9 320.64	322.1 321.80
24+00	25+00	26+00	27+00	28+00	29+00	30+00						

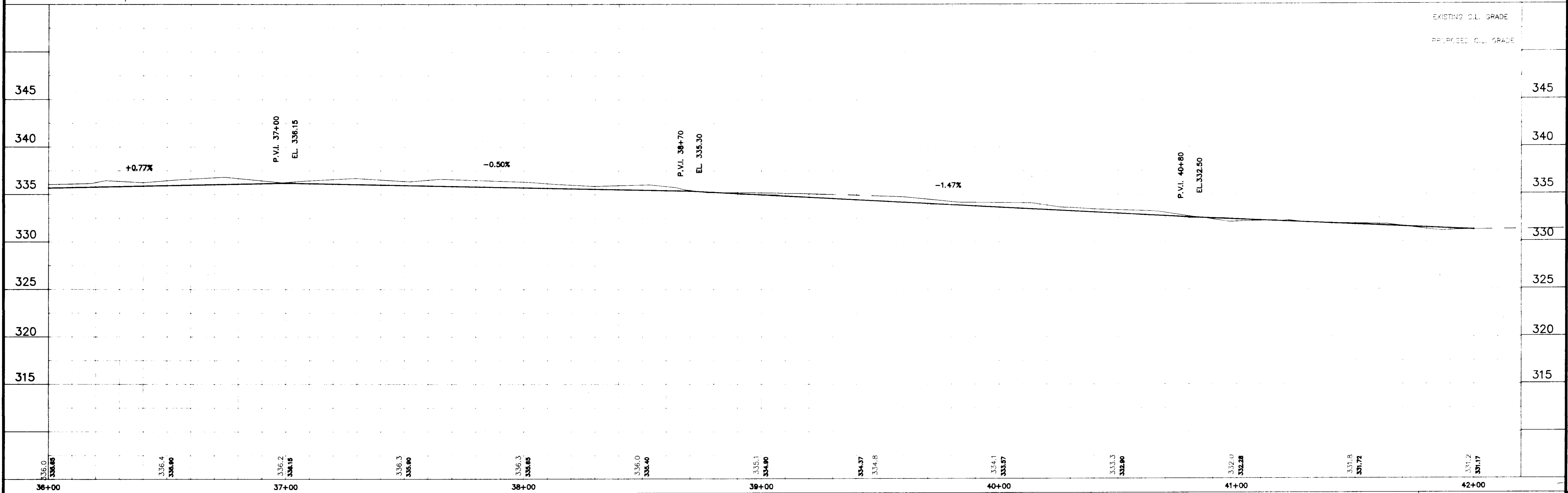
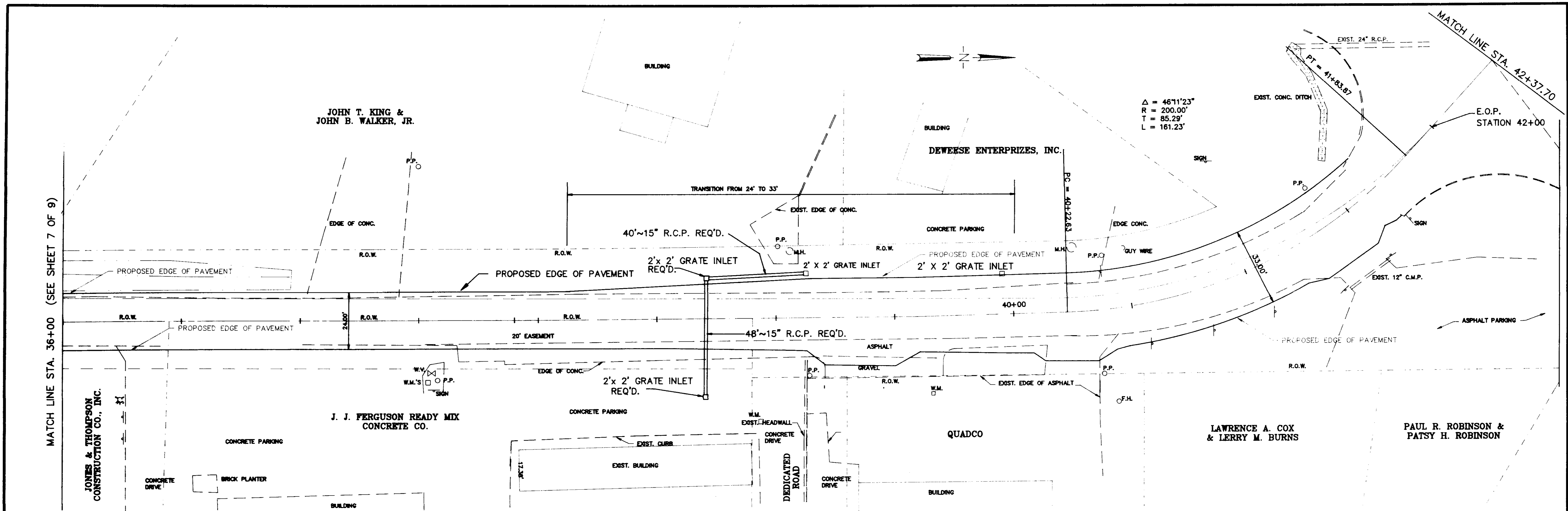

336.0 336.65	336.4 336.90	336.2 336.15	336.3 336.90	336.3 336.85	336.0 336.40	335.1 334.90	334.37 334.8	334.1 333.87	333.3 332.90	332.0 332.28	331.8 331.72	331.2 331.17
36+00	37+00	38+00	39+00	40+00	41+00	42+00						

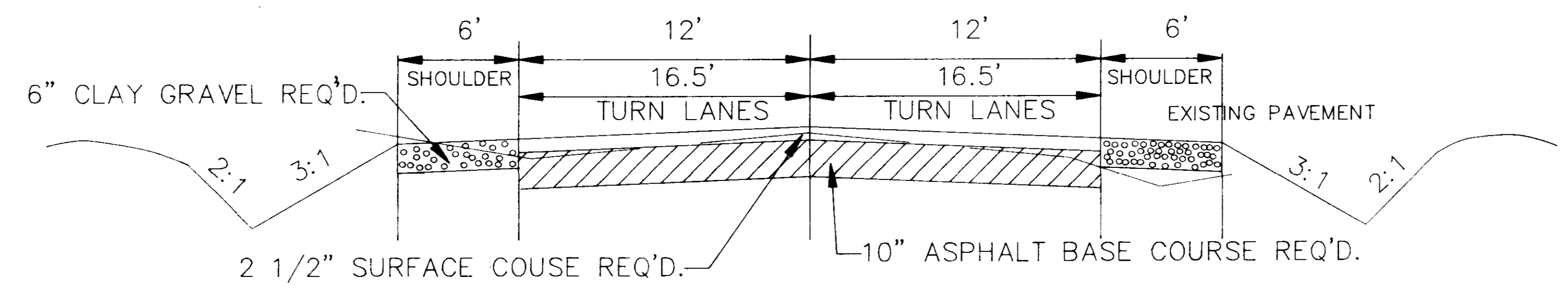

TYPICAL ROADWAY SECTION

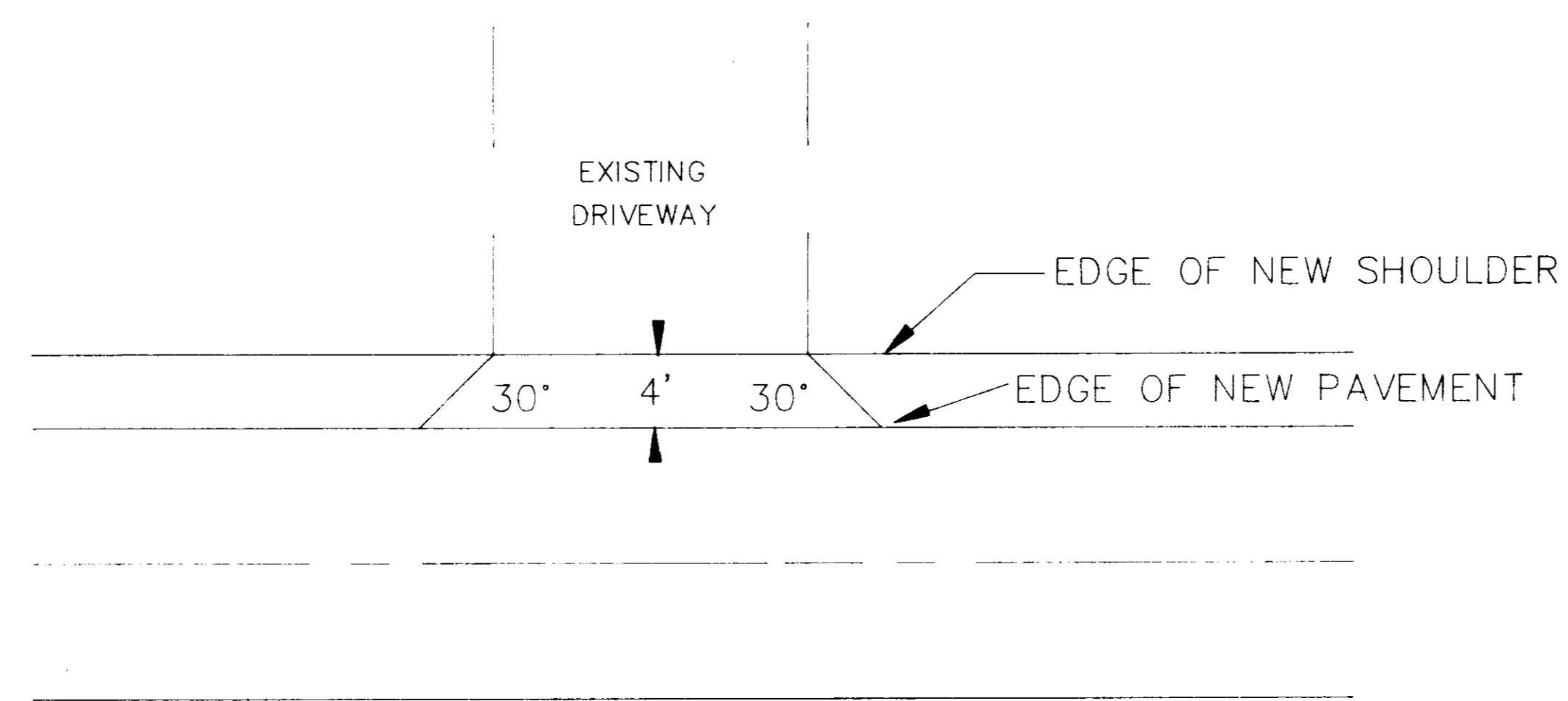

TYPICAL SECTION
DRIVEWAY RAMP

CITY OF RIDGELAND RIDGEWOOD ROAD RECONSTRUCTION		
<small>WAGGONER ENGINEERING, INC. Consulting Engineers - Jackson, Mississippi</small>		
<small>DRAWN BY: H.J.</small>	<small>DATE:</small>	<small>SHEET NUMBER</small>
<small>CHECKED BY:</small>	<small>SCALE: N.T.S.</small>	9 OF 11